

Genetic Algorithm Optimisation of PID Controllers for a Multivariable Process

<https://doi.org/10.3991/ijes.v5i1.6692>

Wael Naji Alharbi

Liverpool John Moores University, Liverpool, UK
w121a@yahoo.com

Barry Gomm

Liverpool John Moores University, Liverpool, UK
j.b.gomm@ljmu.ac.uk

Abstract—This project is about the design of PID controllers and the improvement of outputs in multivariable processes. The optimisation of PID controller for the Shell oil process is presented in this paper, using Genetic Algorithms (GAs). GAs are used to automatically tune PID controllers according to given specifications. They use an objective function, which is specially formulated and measures the performance of controller in terms of time-domain bounds on the responses of closed-loop process. A specific objective function is suggested that allows the designer for a single-input, single-output (SISO) process to explicitly specify the process performance specifications associated with the given problem in terms of time-domain bounds, then experimentally evaluate the closed-loop responses. This is investigated using a simple two-term parametric PID controller tuning problem. The results are then analysed and compared with those obtained using a number of popular conventional controller tuning methods. The intention is to demonstrate that the proposed objective function is inherently capable of accurately quantifying complex performance specifications in the time domain. This is something that cannot normally be employed in conventional controller design or tuning methods. Finally, the recommended objective function will be used to examine the control problems of Multi-Input-Multi-Output (MIMO) processes, and the results will be presented in order to determine the efficiency of the suggested control system.

Keywords—PID control; Multivariable control systems; Parameter optimisation; Genetic Algorithms.

1 Introduction:

The popularity of control and modelling problems is because they are fundamentally related with function optimisation. Optimisation has been employed for the tuning of Proportional, Integral and Derivative controllers (PID). Lopez, et al. [1] used a number of performance indexes based on integrals of functions of the form $f[t, e(t)]$, such as the Integrated Squared Error (ISE) criterion. They used these to develop

graphs that relate the optimal P, PI, and PID controller settings with the three parameters of a first-order dead time process model. A time-domain PID controller tuning method that is based on integral performance criteria was also developed by Dan-Isa & Atherton [2]. More recently, a decentralised PID controller tuning method for multivariable processes was proposed. This is based on the minimisation of an objective function which is derived from standard μ -synthesis (structured singular value) theory [3].

This approach results in PID controllers that achieve improved performance robustness and reliability when faced with process uncertainty and variations in controller output.

It is clear that, as a robust means for optimisation, the genetic algorithm approach fits well within the scope of optimisation-based process modelling and control, where noisy, highly non-linear, multimodal, and discontinuous functions of many dimensions need to be considered and optimised. An overview of the relevance of Genetic algorithms to problems in control engineering can be found in [4]. Genetic algorithms have already been employed in many areas for the solution of modelling and control problems with a high degree of success. A number of successful applications of Genetic algorithms to control systems are presented later in this paper.

2 Design methodology:

Most projected solutions to the Shell standard control problem currently published utilise the state-of-the-art quadratic dynamic matrix control (QDMC) algorithm developed by Shell [5].

In 1986, the Shell Company published the first Shell Process Control Workshop, which discussed the Shell standard control problem. Its aim was to allow the evaluation of new technologies and control theories by providing a standard and realistic test bed [6]. This process consists of a multivariable equation that is a “2-input” and “2-output” of heavy oil molecules. They are subjected to strong reactions, severe restrictions and the large dead times. The infinite number of states they reached whilst, which happened in controlling the unit was the main problem [7]. The key elements of Shell standard control problem are shown in figure 1.

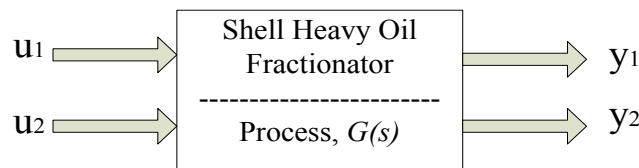

Fig. 1. the Shell standard control problem.

2.1 The output regulation problem:

In the following problem two discrete-time PID controllers both with integral anti-windup loops and derivative term filtering were used to provide the integral actions in

order to reach the requirements of regulation to outputs y_1 and y_2 . The manipulated variables u_1 and u_2 were chosen for closing the two loops of PID controller but u_3 has additional requirements of minimisation, so will not be used in the loops [7]. The inputs u_1 and u_2 are used to control the outputs y_1 and y_2 , occur logically from process operation considerations [6]. The 2×2 matrix of transfer function, which illustrates the Shell oil process, is shown below:

$$G_R(s) = \begin{bmatrix} G_{11}(s) & G_{12}(s) \\ G_{21}(s) & G_{22}(s) \end{bmatrix} = \begin{bmatrix} \frac{4.05e^{-27s}}{50s+1} & \frac{1.77e^{-28s}}{60s+1} \\ \frac{5.39e^{-18s}}{50s+1} & \frac{5.72e^{-14s}}{60s+1} \end{bmatrix} \quad (2)$$

$$y_1 = G_{11}(s) u_1 + G_{12}(s) u_2 \quad (3)$$

$$y_2 = G_{21}(s) u_1 + G_{22}(s) u_2 \quad (4)$$

From equations (3) and (4) the whole structure of the Shell oil process can be illustrated, as seen below.

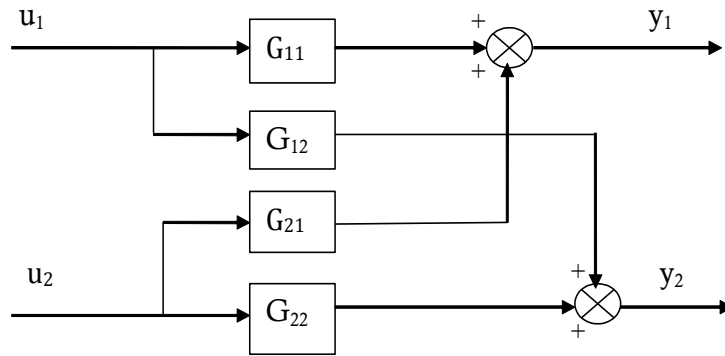

Fig. 2. the Shell oil process

By studying the equation $G_R(s)$ above it is clear that the best pairing of manipulated and controlled variables is to control output y_1 with input u_1 and output y_2 with input u_2 . Moreover, the gains in the main diagonal of $G_R(s)$ are adequately big enough to ensure that the exchanges between the two loops will be smallest.

2.2 PID Controller:

More than 90% of all control loops involve PID controllers [8], due to their simplicity and effectiveness in use they are used in many industrial applications [9]. They are thought to be the most popular controllers used in process control today. The design of PID controllers still poses a challenge to researchers and engineers because every method proposed for tuning these controllers since the 1940s has had its associated limitations and disadvantages.

The PID controller has the following transfer function:

$$K(s) = K_c \left(1 + \frac{1}{T_i s} + T_d s \right) \quad (5)$$

The objective of PID control design is to define the Parameter of the PID controller (K_c, T_i & T_d) to meet a given set point of close loop system performance requirements.

A number of successful PI and PID tuning methods for multivariable processes have been proposed [10], [11] and [12]. All these methods utilise the relay feedback technique developed by [13]. These methods are effective, but are limited in their application because not all classes of multivariable processes can exhibit sustained and near-sinusoidal oscillations under multi-loop relay feedback. In the method presented by [14] the relay switching levels have to be modified manually to bring the process to the correct mode of oscillations. As the process size increases, this task becomes increasing difficult.

3 Objective Functions:

The objective function is as an indicator of how well individuals perform in domain of the problem. In the minimization problem case, the smallest value of the associated objective function will be the reference for the fittest individuals. This raw measure of fitness is usually only used as the stage of intermediate to determine the relative performance of individuals in Genetic Algorithms.

Some most popular objective functions are listed down:

$$\left. \begin{aligned} J_{IAE}(\mathbf{D}) &= \int_0^{\infty} |e(t)| dt & J_{ITAE}(\mathbf{D}) &= \int_0^{\infty} t|e(t)| dt \\ J_{ITSE}(\mathbf{D}) &= \int_0^{\infty} te^2(t) dt & I_{MSE} &= \frac{1}{n} \sum_{i=1}^n (e(t))^2 \end{aligned} \right\} (6)$$

3.1 Evaluation of Performance Criterion:

The experiment will be undertaken to investigate which of the four objective functions gives the best results when used in combination with the Genetic Algorithms. Each of these objective functions will be created for each individual performance criterion.

The Genetic Algorithms will be used for each objective function. The Genetic Algorithms will be adjusted with a population value of fifty and a generation value of fifty. The GAs are applied to tuning the PID for the first part of the Shell process G_{11} as shown in equation 2. Moreover, two examples of objective function performance will be presented.

The IAE and ITAE objective functions were created using the Genetic Algorithms. The result of this optimisation process is shown below.

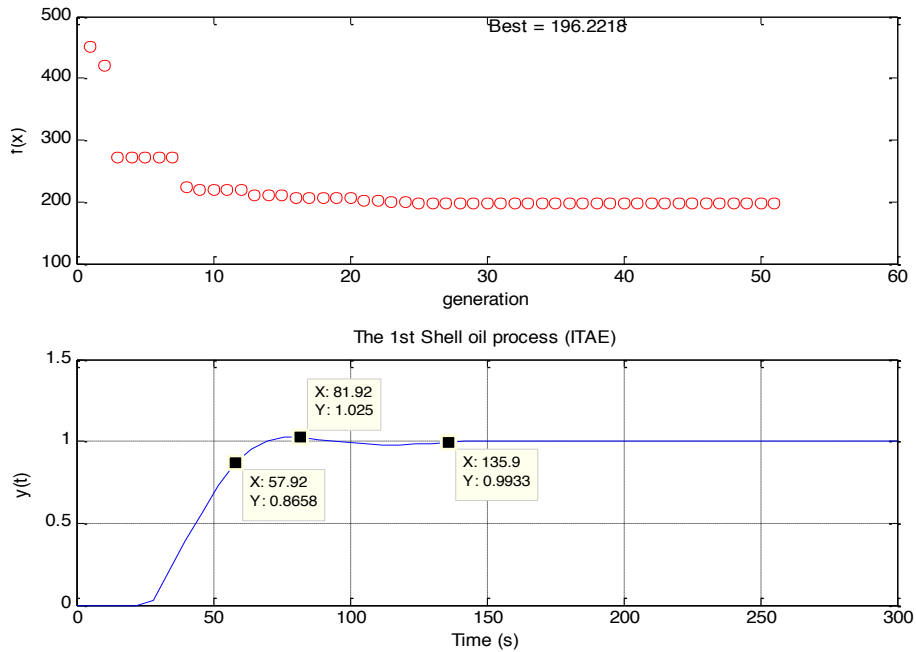

Fig. 3. the GAs process with ITAE objective function.

From this optimisation of PID control, the best or minimum of the objective function (ITAE) is equal (196.22). Moreover, the PID controller parameters, which gave this value of the objective function, are equal:

$$K_p = 0.3868, \quad K_i = 0.0055 \text{ \& \ } K_d = 3.1791$$

Table 1 explains the steady state characteristics such as rise time and overshoot of the outputs of the first part of Shell oil process for each case of the objective functions. Moreover, the results of the PID control tuning using the Zeigler-Nichols method for the first part of Shell oil process will be compared with other results.

Table 1. the comparisons of the steady state responses.

Title	IAE	ITAE	ITSE	MSE	Z-N
Rise Time (s)	50	56	49	46	57.92
% Overshoot	6.8 %	2.5 %	11.79%	15.9 %	8 %
Settling Time (s)	171.9	135.9	171.9	201.9	280

Under the conditions of this experiment, it can be seen that the IAE and ITAE objective functions perform almost identically. They have shorter settling times and overshoot. However, they have a longer rise time than the other controllers.

Each of the PID controllers which are tuned by the Genetic Algorithm outperforms to the PID controller tuned by Ziegler-Nichols Method in terms of rise time and set-

tling time but only the IAE and ITAE objective functions overtake it in terms of overshoot.

The ITAE objective function was chosen as the main performance criterion for the remainder of this project. Because it has a shorter settling time and overshoot than any other method in the whole group.

4 Optimisation of Individual PID Controllers:

This section shows a method of an automatic tuning for parameters of PID controller. In addition, this method can optimise PID control for any process, Shell oil process for example. The method is briefly that applying the Genetic Algorithms with the chosen objective function, which is mentioned in previous section, to single part of Shell oil process. As mentioned in section 2.1 the Shell oil process has two singles process $G_{11}(s)$ and $G_{22}(s)$, and also each process gets PID controller. So, in this chapter the optimal process of PID control for Shell oil process will apply to the two singles process $G_{11}(s)$ and $G_{22}(s)$. After optimising process, the given parameters of the both PID controllers will be tested to the multivariable process of the Shell oil process. Finally, the test results will be used in next section for comparing with another method's results.

4.1 Optimise the Performance of PID control for $G_{11}(s)$:

The transfers function of first part of Shell oil process $G_{11}(s)$ has been used in previous section with ITAE objective function. Moreover, the minimum value of the objective function was equal 196.22. The PID controller parameters were equal;

$$K_p = 0.3868, \quad K_i = 0.0055 \quad \& \quad K_d = 3.1791$$

Therefore, by these results, the PID control optimisation for the first part of Shell oil process is achieved.

4.2 Optimise the Performance of PID control for $G_{22}(s)$:

By using equation 1 in section 2, the second single of the Shell oil process ($G_{22}(s)$) is defined as;

$$G_{22}(s) = \frac{5.72e^{-14s}}{60s+1} \quad (7)$$

After running the Genetic Algorithms via $G_{22}(s)$, we have got the results below:

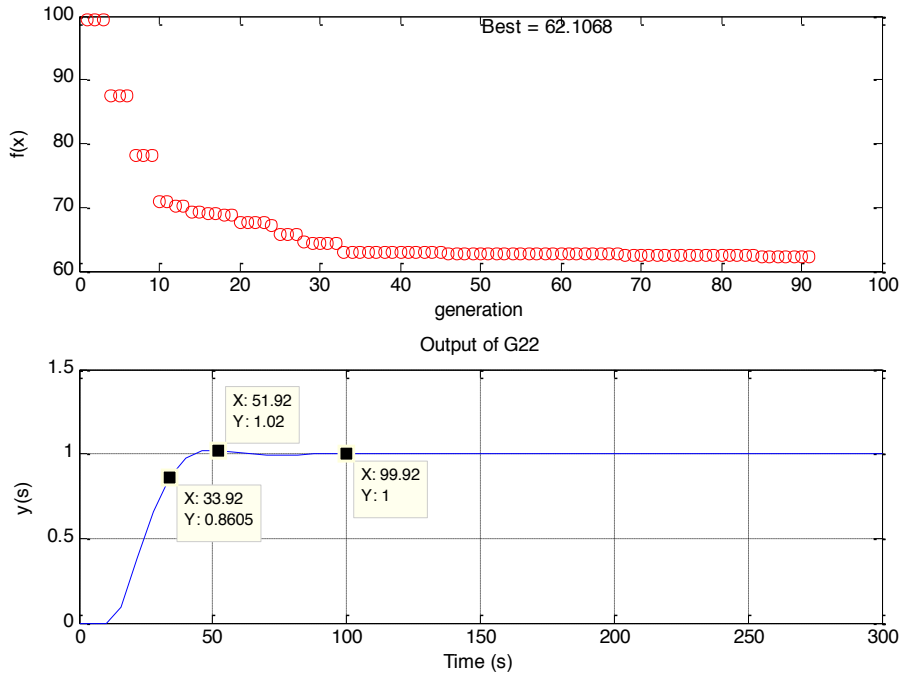

Fig. 4. the optimisation of PID control for $G_{22}(s)$.

The best ITAE objective function for this optimisation process is equal (62.1068) and this value is achieved by using the following parameters of the PID controller.

$$K_p = 0.509 ,$$

$$K_i = 0.0070 \text{ \& } K_d = 1.69$$

From figure 4 it can be seen that the output graphs show no overshoot and short settling time which are the system targets. In addition, the optimisation of the second part of the Shell oil process is completed. The next step is using the given PID parameters for the two processes $G_{11}(s)$ and $G_{22}(s)$ to apply them into multivariable process of the Shell oil process as will be shown in next section.

5 Controller Performance on Multivariable process:

In section 2; the design of shell oil process was presented with their 2×2 transfer function matrix as shown in equation 2.1, which will be used for multivariable process of Shell oil. In the two previous sections the suitable parameters of the two PID controllers were achieved. In this section the multivariable Shell oil process will be tested with two PID controllers.

To simulate this Multi Input Multi Output Shell oil Process, we should use the Matlab/Simulink. The Simulink model of this process is shown in following figure.

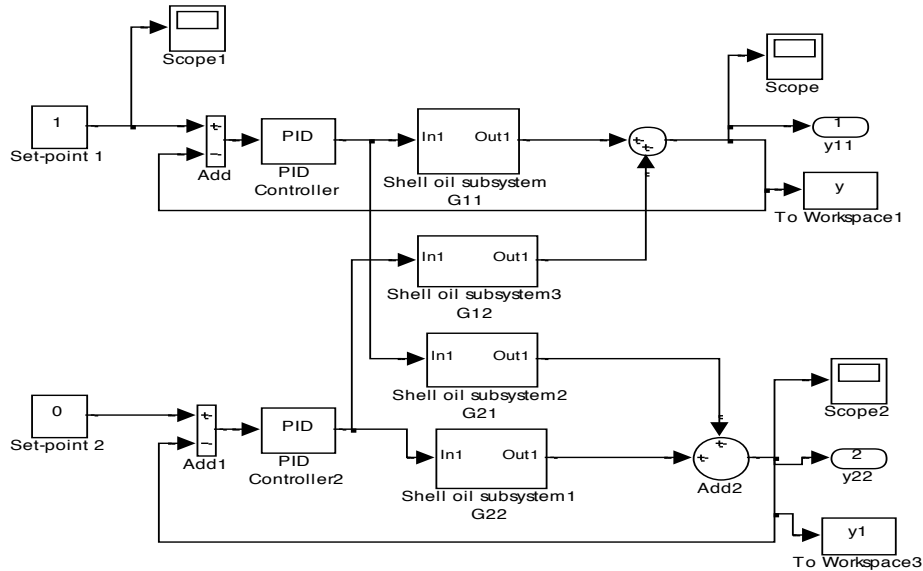

Fig. 5. the Simulink model of Shell Oil process.

To test the performance of the PID controller for this closed loop multi-process, we should follow the steps below.

1. Apply the parameters of the PID controllers, which have been found in the previous sections.
2. For multi-process we need first apply the set-point ($r_1(t)$) into the first input ($u_1(t)$), to realise the performance of the first output ($y_1(t)$). However, there is no set-point applied to second input ($u_2(t)$). By running the multi-process for 300 seconds, the outputs graphs will be shown as figure 6.
3. To test the performance of the second output ($y_2(t)$), the set-point ($r_2(t)$) should be applied into the second input ($u_2(t)$), but the set-point ($r_1(t)$) should be zero. After the Multi process is generated for the same time in step 2, we can have the following figure 7.

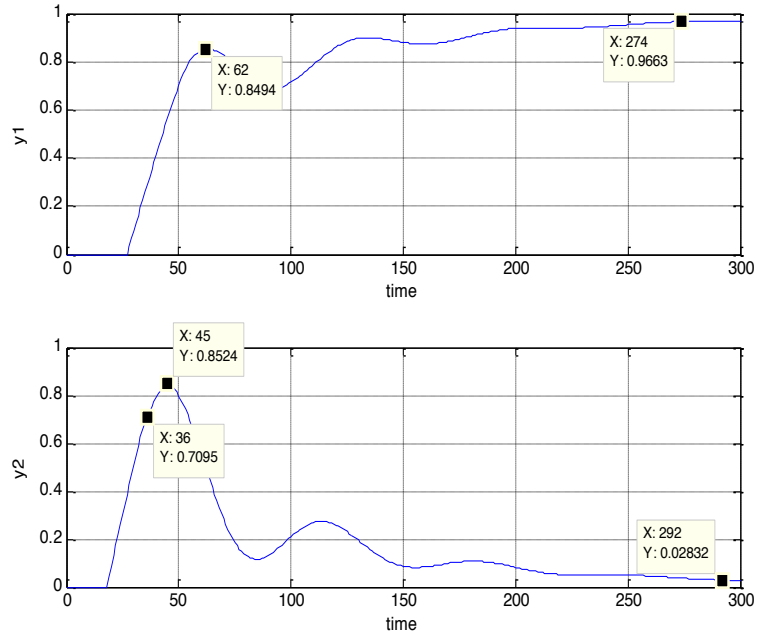

Fig. 6. The Multi process outputs when $r_1=1$ & $r_2=0$.

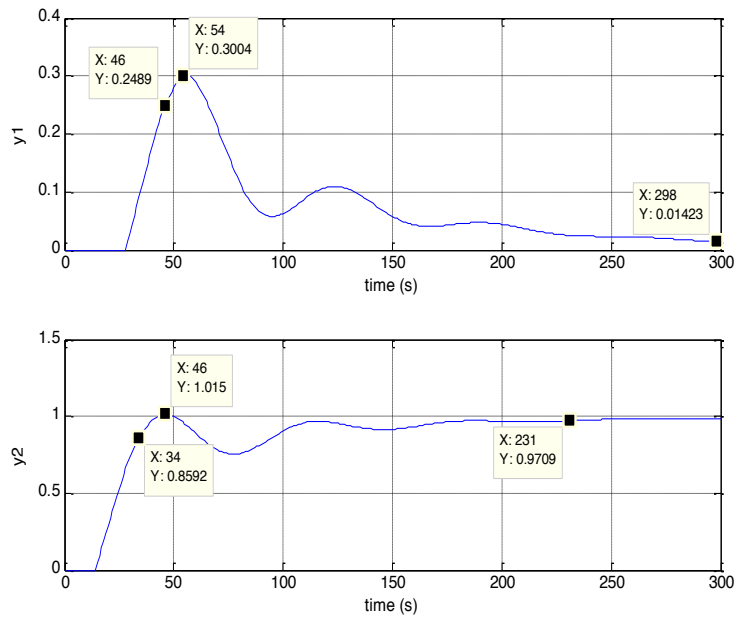

Fig. 7. the Multi process outputs when $r_1=0$ & $r_2=1$

6 Optimisation of Multi PID Controllers for Multivariable Process:

This section explains and describes a new technique for the automatic tuning of PID controllers for multivariable process, based on the Genetic Algorithms. The main advantage of this technique is that it allows the engineers to explicit specify the specifications of the required performance for a given problem of multivariable control, whereas the time-domain limits on the closed loop responses. This can be realised by designing a function optimisation problem from the control problem, using the objective function J_{ITAE} which was described in section 4. Next, the Genetic Algorithms will be employed to minimum the objective function J_{ITAE} , in order to optimise PID control for multivariable process. In addition, the projected method can be valid to a wide range of multivariable processes. Simulation results will be presented and compared with the simulation results from the previous chapter.

In this section, a multi-loop PID controller will be optimised for Multivariable process of the Shell oil. After transferring the control problem into function optimisation problem using the objective function J_{ITAE} and three parameters of PID controller loops in the closed loop of multivariable system.

The projected PID tuning method is working by decreasing the objective function J_{ITAE} which is the function for the parameters of the PID controller related with PID tuning problem.

To optimise the multi loop of PID controller by this tuning method, the following steps should be undertaken:

1. The selected objective function (ITAE) should be employed to this multivariable process.
2. Genetic Algorithms should be checked to be used for G(s) multivariable process and the ITAE objective function.
3. For solving the problems with typical set-point tracking and loop coupling performance specifications, we can suggest a number of closed loop test which will be in our case two closed loop tests, especially in cases where the process of the controller is non-linear and also different operating point should be evaluated in candidate controllers.

The following figure describes the closed loop test 1 and 2.

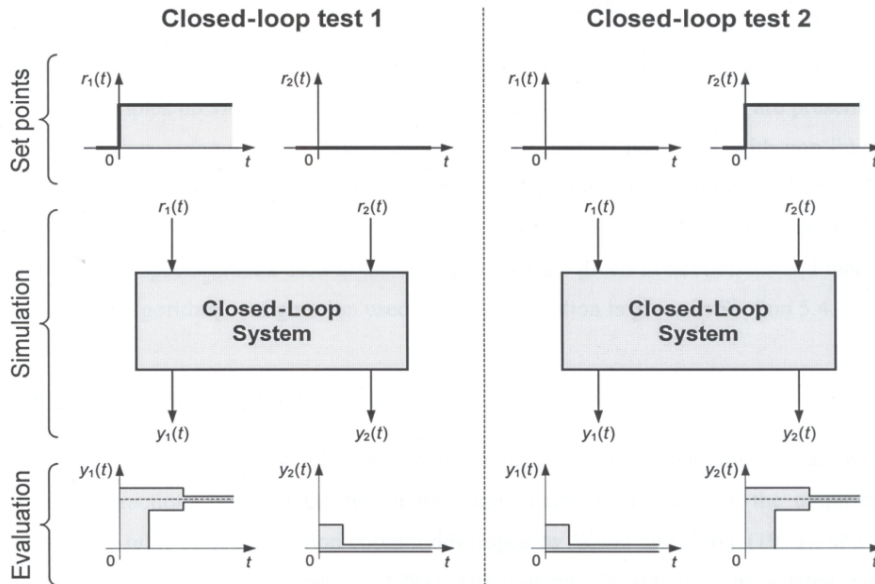

Fig. 8. closed loop test 1&2.

6.1 Simulation Results of Optimisation Method 1:

The simulation process will take two methods and each method will have two closed loop test. The first method is running GAs with ITAE objective function where the error will be calculated from y_1 in case of the first closed loop test, but in case of the second closed loop test the error will be calculated from y_2 . Furthermore, the second method of this simulation process the ITAE objective function will be calculated from both errors e_1 and e_2 for both cases of the closed loop test.

In this method we will have two closed loop test as mentioned in previous, to start with the first closed loop test we should follow the steps below.

1. Apply the set-point into the box of the set-point r_1 with no set-point in r_2 .
2. To active PID controller of the second loop, we will apply the given parameters of the second part of the Shell oil process $G_{22}(s)$ from section 5.

After running Genetic Algorithms with suitable populations and generations. The results are shown in figure below.

Figure 9 shows the optimisation process for the first loop of PID controller, and also it gave the minimum objective function which equals 1470.42. This value of objective function can be achieved with Parameters of the first PID controller equals.

$$K_p = 0.3871, K_i = 0.0095$$

$$K_d = 2.0734$$

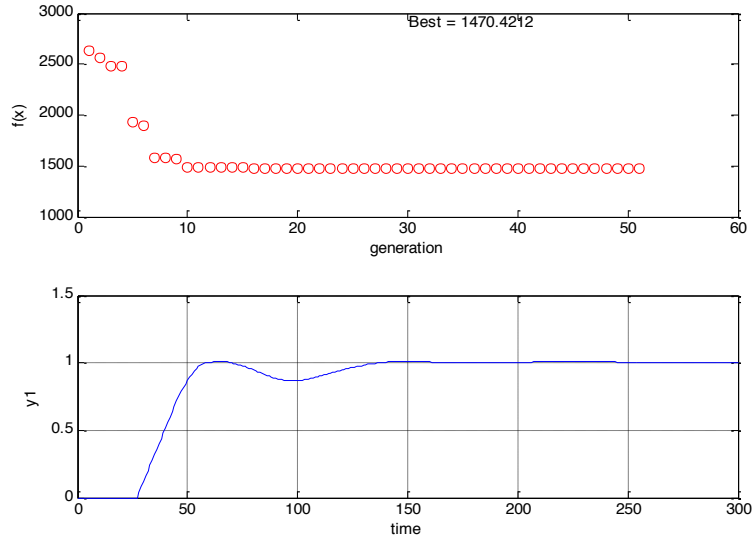

Fig. 9. first loop optimisation.

Figure 10, shows the optimisation process for the second loop of PID controller is realized, and also it gave the best value of objective function which equals 855.99. This value of objective function can be achieved with Parameters of the second PID controller equals.

$$K_p = 0.8929, \quad K_i = 0.0126 \text{ \& } K_d = 6.4289$$

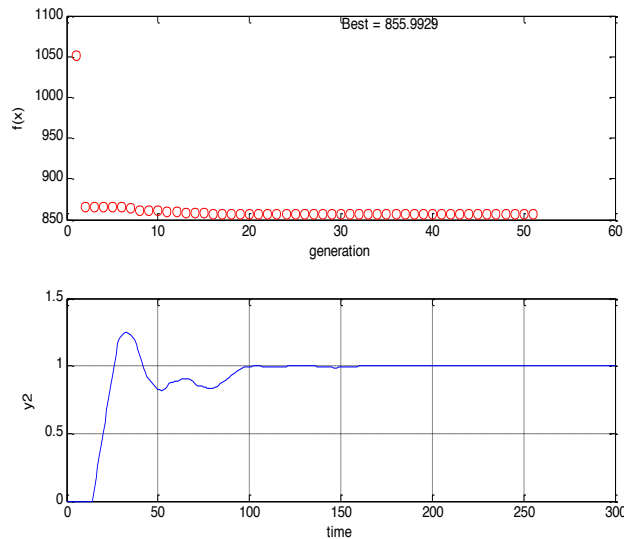

Fig. 10.the second loop optimisation process.

To test the PID controller for two closed-loop control, the achieved PID controllers' parameters in closed loop tests 1 and 2 should be applied. Then, the results are shown below in two ways.

Firstly, the outputs y_1 and y_2 are shown in conditions of set-points ($r_1=1$ & $r_2=0$), as displayed in figure 11.

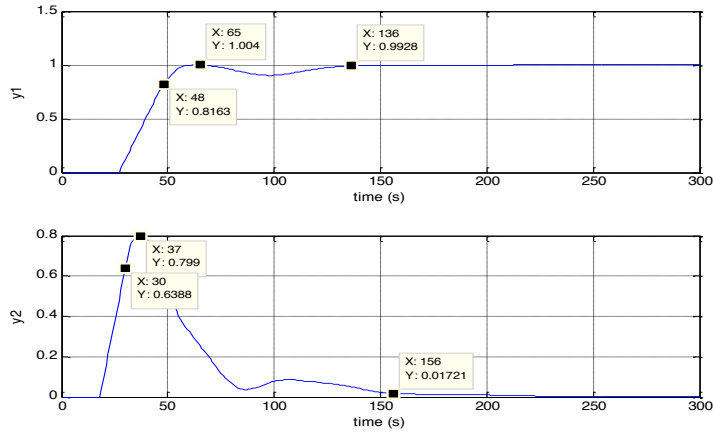

Fig. 11. the outputs of the 1st method of the optimisation process when ($r_1=1$ & $r_2=0$).

Secondly, the outputs y_1 and y_2 will be shown in conditions of set-points ($r_1=0$ & $r_2=1$), as displayed figure 12.

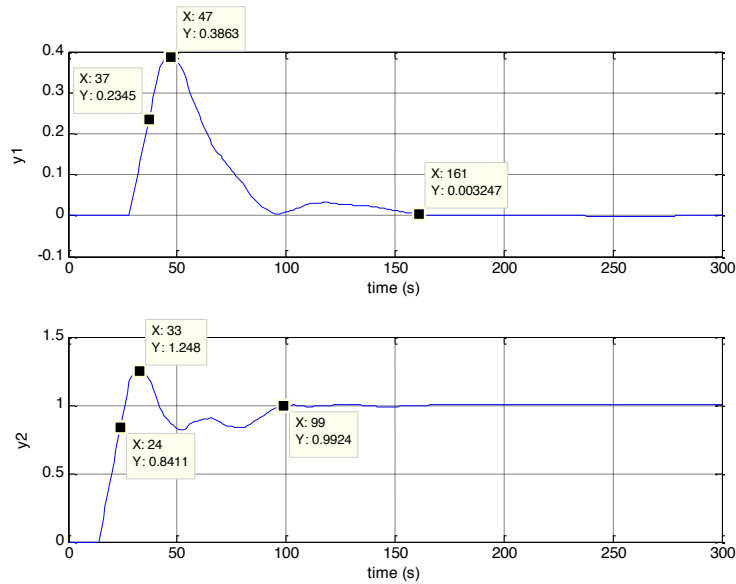

Fig. 12. the outputs of the 1st method of the optimisation process when ($r_1=0$ & $r_2=1$).

6.2 Simulation Results of Optimisation Method 2:

The action steps of this method are the same in the previous section. However, there will be some changes in the ITAE objective function. In previous section, the equation of ITAE used one value of the error which was calculated from one output for each closed-loop test but in this section the ITAE equation will use two values of error, the error values from y_1 and y_2 as shown below.

The general equation of ITAE objective function is shown in equation 7.

To calculate the error ($e(t)$) we need to use the following equation.

$$e(t) = y(t) - r(t) \quad (12)$$

Where $y(t)$ is output and $r(t)$ is set-point.

Form equations (7) and (12) we can have.

$$J_{ITAE}(D) = \int_0^{\infty} |(e_1(t) + e_2(t))| t dt \quad (13)$$

Where:

$$e_1(t) = y_1(t) - r_1(t) \quad \& \quad e_2(t) = y_2(t) - r_2(t) \quad (14)$$

In this section, we should note that, the set-points of the first closed-loop test should be $r_1(t) = 1$ & $r_2(t) = 0$, but the opposite should be applied to another closed-loop test.

Firstly, to optimise PID control for the first PID controller, as mentioned in section a, the first closed-loop test should be achieved. However, we should note that the parameters of second PID controller which have been achieved for process $G_{22}(s)$ in section 5 should be applied, as in previous section.

Secondly, the equation 13 of ITAE objective function should be designed in Matlab's M-file.

Thirdly, the M-file of the proposed objective function should be applied to Genetic Algorithms toolbox.

Then, Genetic Algorithms will be run to optimise PID control for the first loop of PID controller, and the outcomes are shown in following figure.

In figure 13, the optimisation process for first loop of PID controller is realized, and also it gave the best value of objective function which equals 3350.55, as mentioned above this value of objective function is sum of two errors (e_1 & e_2). In addition, it can be achieved with parameters of the first PID controller equals.

$$K_p = 0.5242, \quad K_i = 0.0109 \quad \& \quad K_d = 1.6879$$

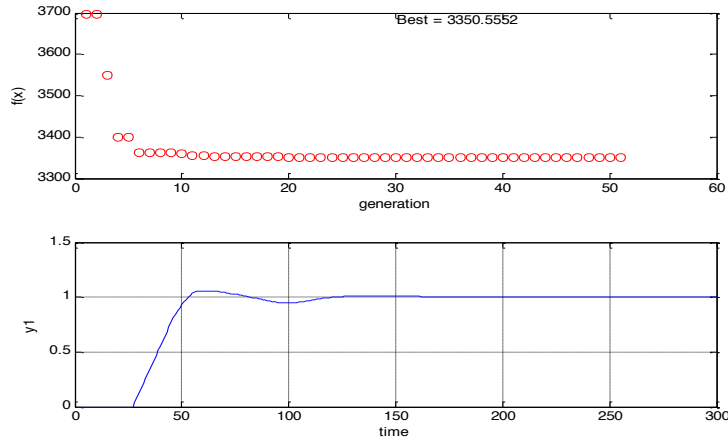

Fig. 13.optimisation of PID control for multivariable process (2nd method-test 1)

By this result, the first closed-loop test is completed. Next, the second closed-loop test should be run after some changes are required in the Genetic Algorithms M-file. To let the optimisation process work with the second PID controller loop. Furthermore, the set-points should be changed as shown in figure 6.

After the operation of the Genetic algorithms is finished, we can have the following results.

Figure 14 shows the optimisation process for second loop of PID controller, and also it gave the minimum objective function which equals 1676.88. This value of objective function can be achieved with Parameters of the second PID controller equals.

$$K_p = 0.9349, \quad K_i = 0.0121 \text{ \& } K_d = 6.6259$$

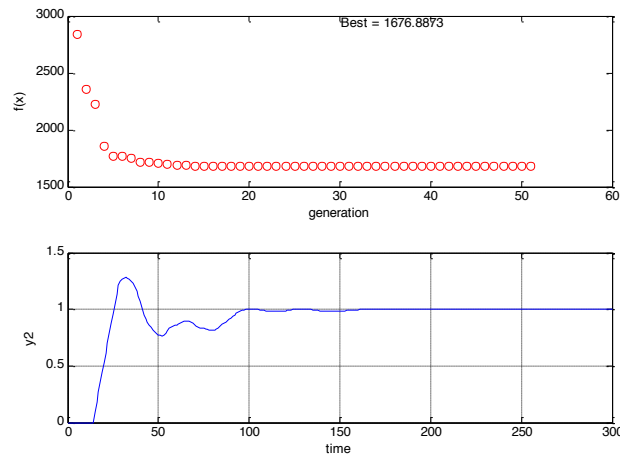

Fig. 14.Optimisation of PID control for multivariable process (2nd method-test 2).

By this result, the first and second closed-loop tests are completed. Moreover, to test the PID controller for two closed-loop control, the achieved PID controllers parameters from second optimisation method in closed loop test 1 and 2 should be applied. The results can be shown in two ways.

Firstly, the outputs y_1 and y_2 can be shown in conditions of set-points ($r_1=1$ & $r_2=0$), as displayed in figure 15.

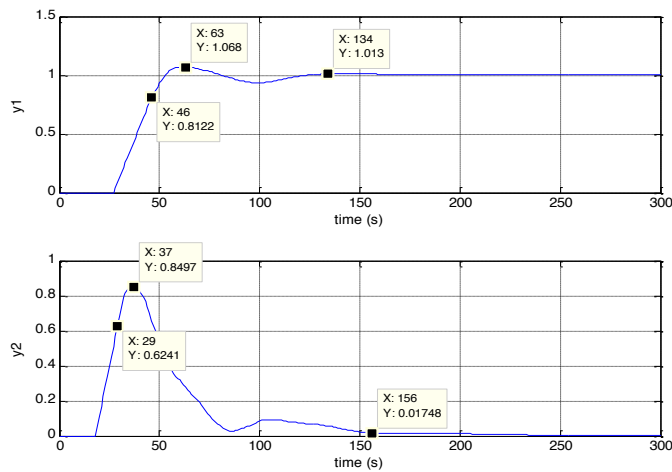

Fig. 15. the outputs of the 2nd method of the optimisation process when $r_1=1$ & $r_2=0$.

Secondly, the outputs y_1 and y_2 can be shown in conditions of set-points ($r_1=0$ & $r_2=1$), as displayed in figure 16.

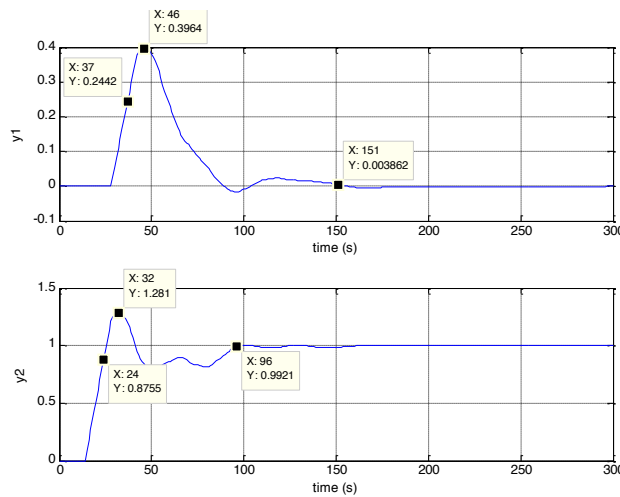

Fig. 16. the outputs of the 2nd method of the optimisation process when $r_1=0$ & $r_2=1$.

6.3 Comparisons of Performance for the PID Controller Optimisation:

In this section, the performance of PID control will be compared and discussed. Firstly, the results from table 5.1, which are for the characteristics of the multivariable process outputs after optimising PID control using individually PID controller tuning, will be compared with the results from table 6.1, that shows the characteristic of multivariable process outputs after optimisation process for PID control using multi closed-loop PID controller tuning, to see which of these optimisation methods are better and more successful.

From graphs in figures 6, 7 as individually tuning and figures 11 and 12 as multi-loop tuning, we can have the following table:

Table 2. the comparisons between individually and multi-loop PID controller tuning.

Title	Multi-process ($r_1=1$ & $r_2=0$) individually PID controller tuning		Multi-process ($r_1=1$ & $r_2=0$) multi-loop PID controller tun- ing	
	y_1	y_2	y_1	y_2
Rise time (s)	62	36	48	30
Overshoot %	Non	85%	0.4%	79.9%
Settling time	274	292	136	156
ITAE	4703.9		1470.42	
Title	Multi-process ($r_1=0$ & $r_2=1$) individually PID controller tun- ing		Multi-process ($r_1=0$ & $r_2=1$) multi-loop PID controller tun- ing	
	y_1	y_2	y_1	y_2
Rise time (s)	46	34	37	24
Overshoot %	30%	1.5%	38%	24%
Settling time	298	231	161	99
ITAE	2326.1		855.99	

From above table, it is clear to see that the rise time is decreasing in case of optimising of multi-loop PID control than individual tuning of PID controller. However, there is some differences between overshoots, for example, in the set-points $r_1=1$ & $r_2=0$, the overshoots in case of multi-loop PID controller tuning are smaller than individual tuning but in another case of set-points the opposite is correct. The Optimisation of multi-loop PID control gives shorter settling time for the outputs of multivariable process than individually PID controller tuning. Moreover, the values of ITAE objective function for multi-loop PID control optimising are smaller than ITAE values from individual optimisation of PID control. Finally, the optimisation process can give better results for PID control when it is applied to multi-loop PID controller, than using individual optimising for PID control.

Secondly, after the comparisons between individual optimisation of PID control and multi-loop PID controller optimising is achieved, the two methods of optimisation process for multi-loop PID controller will be compared and dissected. The following table shows some differences for these two methods.

Table 3. the comparisons between the optimisation methods of multi-loop PID controller.

Title	Multi-process ($r_1=1$ & $r_2=0$) The 1 st optimisation method		Multi-process ($r_1=1$ & $r_2=0$) The 2 nd optimisation method	
	y_1	y_2	y_1	y_2
Rise time (s)	48	30	46	29
Overshoot %	0.4 %	79.9%	0.6 %	84.9%
Settling time	136	156	134	156
ITAE	1470.42	43268	1142.7	1918.1
Title	Multi-process ($r_1=0$ & $r_2=1$) The 1 st optimisation method		Multi-process ($r_1=0$ & $r_2=1$) The 2 nd optimisation method	
	y_1	y_2	y_1	y_2
Rise time (s)	37	24	37	24
Overshoot %	38%	24%	39.6%	28%
Settling time	161	99	151	96
ITAE	44453	855.99	755.36	785.2

As we have seen in above comparisons table, there is an improvement in characteristics of the outputs for the second optimisation method rather than the first optimisation method. moreover, the ITAE values are the smallest in case of the second optimisation method. Because in first method of optimisation is just minimising the ITAE objective function form one kind of error which is calculated from one output (y_1 or y_2), rather than the second optimisation method which used to minimise ITAE for two errors e_1 and e_2 which was calculated from y_1 and y_2 .

7 Conclusions:

This project examined the possibility of the use of Genetic Algorithms for the optimal solution of control problems in framework of the function optimisation, which focuses on control of multivariable process. Some indexes of performance and controller tuning methods were analysed and developed. Moreover, the Genetic Algorithms were extended for enabling them to identify multiple solutions of optimal equivalent for a given problem.

The performance of PID control as shown in section 3 was shown that the design of the PID controller's parameter using Genetic Algorithms has better results in the

characteristics of outputs, such as rise and settling time, than using the classical methods. However, the classical methods, such as Ziegler-Nichols tuning method, are good for giving the start point of determination for the parameters of PID controller. In addition, section 3 displayed that the analysis of objective functions using the comparison of their performance criterion for optimising the PID control optimising. This comparison was decided that the Integral of Time multiplied by Absolute Error (ITAE) performance criterion based objective function produced the most effective PID controllers when was compared with performance criterion of other objective functions, such as ISE, ITSE and MSE.

In section 4, the method for automatic tuning of PID controller for Single-Input, Single-Output (SISO) was presented, and also the suggestion parameters of the PID controllers are applied to Multi-Input, Multi-Output (MIMO) for Shell oil process. Moreover, it not easy to optimise the PID control for multivariable process, but in sections 4.2 and 4.3 the Genetic Algorithms have successfully employed to optimise the multi closed-loop of PID control. The comparison table 2 shows that the optimisation of PID control for multivariable process produces better performance than the PID control optimisation for single process.

8 References:

- [1] Lopez, A. M. Miller, J. A. Smith, C. L. And Murrill, P. W. (1967). "Tuning controllers with error-integral criteria". Instrumentation Technology. November Issue, 57-62.
- [2] Dan-Isa, A. And Atherton, D. P. (1997). "Time-Domain Method for the Design of Optimal Linear Controllers". IEE Proceedings on Control Theory and Applications. 287-292. <https://doi.org/10.1049/ip-cta:19971140>
- [3] Gagnon, E. Pomerleau, A. And Desbiens, A. (1999). "Mu-Synthesis of robust decentralised PI controllers". IEE Proceedings on Control Theory and Applications. 146, 4, 289-294. <https://doi.org/10.1049/ip-cta:19990324>
- [4] Zalzal, A. M. S. and Fleming, P. J. (1996). "Genetic algorithms: Principles and applications in engineering systems". Neural Network World. 6, 5, 803-820.
- [5] Garcia, C. E., & Morshedi, A. M. (1986). "Quadratic programming solution of dynamic matrix control (QDMC)". Chemical Engineering Communications. 46, 73-87. <https://doi.org/10.1080/00986448608911397>
- [6] Prett, D. M. & Morari, M. (1987). "The Shell process control workshop". London, Butterworths.
- [7] Vlachos, C. Williams, D. Gomm, J.B. (2001). "Solution to the Shell standard control problem using genetically tuned PID controllers". School of Engineering, LJMU, Liverpool, UK.
- [8] Koivo, H. N. And Tanttu, J. T. (1991). "Tuning of PID Controllers: Survey of SISO and MIMO Techniques in Proceedings of Intelligent Tuning and Adaptive Control". Singapore.
- [9] Astrom, K. J. And Hagglund, T. (1998). "Automatic Tuning of PID Controllers". Instrument Society of America.
- [10] Loh, A. P., Tan, W. W., and Vasnani, V. U. (1994). "Relay feedback of multivariable systems and its use for auto-tuning of multi-loop PI controllers". Proceedings of the International Conference on Control. IEE, 1049-1054. <https://doi.org/10.1049/cp:19940280>

- [11] Halevi, Y. Palmor, Z. J. And Efrati, T. (1997). “Automatic tuning of decentralized PID controllers for MIMO processes”. Journal of Process Control. 7, 2, 119-128. [https://doi.org/10.1016/S0959-1524\(97\)82769-2](https://doi.org/10.1016/S0959-1524(97)82769-2)
- [12] Semino, D. And Scali, C. (1998). “Improved identification and auto-tuning of PI controller for MIMO processes by relay techniques”. Journal of Process Control. 8, 3, 219-227. [https://doi.org/10.1016/S0959-1524\(97\)00041-3](https://doi.org/10.1016/S0959-1524(97)00041-3)
- [13] Astrom, K. J. And Hagglund, T. (1998). “Automatic Tuning of PID Controllers”. Instrument Society of America.
- [14] Loh, A. P., Tan, W. W., and Vasnani, V. U. (1994). “Relay feedback of multivariable systems and its use for auto-tuning of multi-loop PI controllers”. Proceedings of the International Conference on Control. IEE, 1049-1054. <https://doi.org/10.1049/cp:19940280>

9 Authors

Wael Naji Alharbi is with Liverpool John Moores University, GERI, Byrom Street, L3 3AF Liverpool, UK. PhD Student in Control system Engineering. MSc in Power and control engineering (w.alharbi@outlook.com).

J. Barry Gomm received the BEng(Hons) first class degree in Electrical and Electronic Engineering in 1987 and the PhD in process fault detection in 1991 from Liverpool John Moores University (LJMU), UK. He joined the academic staff at LJMU in 1991 and is a Reader in Intelligent Control Systems. He was co-editor of the book “Application of Neural Networks to Modelling and Control” (London, UK: Chapman and Hall, 1993) and has been Guest Editor for several journal special issues including Fuzzy Sets and Systems and Transactions of the Institute of Measurement and Control. In 2011, Dr Gomm as co-author received the IFAC award for most cited paper in the journal Engineering Applications of Artificial Intelligence. He has published more than 140 papers in international journals and conference proceedings. Dr Gomm is a member of the IET and IEEE, and has served on an IET committee and organising committees of several conferences. His current research interests include neural networks for modelling, control and fault diagnosis of non-linear processes; intelligent techniques for control; system modelling and identification; adaptive systems and algorithms; analysis, control and stability of non-linear systems. Applications include automotive engines; chemical, biochemical and manufacturing industrial processes (j.b.gomm@ljmu.ac.uk, ORCID iD: 0000-0002-1777-8850).

Article submitted 24 January 2017. Published as resubmitted by the authors 03 March 2017.