

Developing Tele-Operated Laboratories for Manufacturing Engineering Education

Platform for E-Learning and Telemetric Experimentation (PeTEX)

[doi:10.3991/ijoe.v6s1.1378](https://doi.org/10.3991/ijoe.v6s1.1378)

C. Terkowsky¹, I. Jahnke¹, C. Pleul¹, R. Licari², P. Johansson³, G. Buffa², M. Heiner¹, L. Fratini²,
E. Lo Valvo², M. Nicolescu³, J. Wildt¹, A. E. Tekkaya¹

¹ TU Dortmund University, Dortmund, Germany

² University of Palermo, Palermo, Italy

³ Kungliga Tekniska Högskolan (KTH), Stockholm, Sweden

Abstract—The aim of the PeTEX-project is to establish an e-Learning platform for the development, implementation, and delivery of educational training programs in the field of manufacturing engineering. The PeTEX team designs both: a technical platform for eLearning based on “Moodle” including distributed tele-operated experimentation facilities, and didactic and socio-technical requirements for a successful online learning community. User interfaces are deployed for remote access to instruments, data analysis and multiplexed data access via network protocols. Hence, the platform provides complex tools in order to perform various activities to support the educational process, from telemetric experimentation to virtual project groups for an entire community to the purpose of domain specific learning. This paper describes important steps of interdisciplinary participatory design and development of a remote lab-prototype in the field of manufacturing engineering.

Index Terms—Engineering education, e-learning, interactive systems, international relations, laboratories, learning systems, online learning, remote laboratories, experiments.

I. PETEX PROJECT OBJECTIVES

A. General aims of the project

The EU-funded project *PeTEX-Platform for e-Learning and Telemetric Experimentation* (project-code: 142270-LLP-1-2008-1-DE-LEONARDO-LMP; duration: 2008-2010)—aims to design and establish a prototype of an e-learning platform for the development, implementation, and delivery of educational and training programs in the field of manufacturing engineering. The development of tele-operated experimentation and its provision to distance learners opens new dimensions of knowledge acquisition, particularly where experiments are the core elements of learning, as in [1], [2], [3], and [4].

Remote laboratories in engineering education are nothing new. According to [5], a wide range of distance learning environments have been developed and deployed over the last decade, particularly in electronics, microelectronics, control engineering and robotics. However, remote “hands on”- laboratories in *production* engineering education, surprisingly, do not yet exist.

The unique aspect of the PeTEX environment is that teaching and learning arrangements involve interactive live experiments through a real-time video-based access

into three physical-real laboratories in the fields of forming, cutting, and joining [6].

The physical-real laboratories are located in the three European countries of Germany (TU Dortmund University, Institute of Forming Technology and Lightweight Construction - IUL), Italy (University of Palermo, Department of Mechanical Technology, Production and Management Engineering - DTMPiG), and Sweden (Stockholm Technology University, Department of Production Engineering - KTH). The Center for Research on Higher Education and Faculty Development (TU Dortmund University, HDZ) contributes to the development and deployment of the educational model and moderates all collaborative designing processes during project lifetime.

The principle goal of this project is to establish individual and group oriented learning within a platform-system able to sustain a multi-country learning community in the field of manufacturing engineering.

Hence, an educational model is designed which integrates the tele-operated experimentation platform with teaching content and learning activities in order to support a successful learning walkthrough.

A framework to integrate the technical, educational and social dimensions in the design is provided by the approach of socio-technical systems and networks [7]. Instances of learning and teaching in socio-technical environments provided by the participatory design discourse suggest that new approaches should be situated in a specific context and embedded within social interactions and didactical methods [8], [9]. Reshaping blended and co-located learning needs the analysis and design of social processes, technical interactions, and educational methods.

B. Objectives of tele-operated experiments in manufacturing engineering

The objective of tele-operated experiments in manufacturing engineering is to enable learners in the field of mechanical engineering to effectively carry out material characterization tests with the uniaxial tensile test (1), to weld metal sheets using the innovative technique of friction stir welding (FSW) (2) and to set up the appropriate parameters for an effective cutting process as well as to gain knowledge in advanced material and machining process monitoring and optimization (3).

Within the subject of forming, one of the most important tests for material characterization – the uniaxial tensile test – has been adapted for tele-operated usage. Furthermore, the aspect of joining will be included in the telemetric experiment for friction stir welding (FSW), a solid-state welding process. Such an approach allows students to remotely control and use a CNC milling machine in order to perform a number of FSW experiments and to test the joints by remotely using a testing machine.

The learner will be guided along a learning path aimed at

1. introducing the basics of the tensile test-, FSW-, and milling-process
2. identifying the most relevant process issues and, in particular, the fixtures and tools to be used as well as the fundamental process parameters affecting the process mechanics
3. evaluating the success of the entire procedure.

The tele-operated experiments are implemented within the learning environment in order to conduct material characterization (1), friction stir welding (2), and optimization of the milling operation (3), and thus providing the learner with the relevant domain specific knowledge as well as the backgrounds of these processes.

II. PEDAGOGICAL CONCEPT

Current discussions in higher education centre on the turn “from teaching to learning” [10]. Concepts promoting the shift from teacher-centered teaching to student-centered learning concepts are nothing new. However, discussions about didactic and educational learning approaches have gained impetus as new community platforms emerged. The new approach claims to support teaching and learning differently. It holds that a new balance between teaching and learning is essential for supporting creativity and best learning effects. Learning-centered approaches promote a re-orchestration of teaching and learning arrangements where learning is regarded from the learners’ viewpoint.

In this contribution, learning is defined with the constructivist approach, positing that learning processes are socially constructed: “Learning is an active process of constructing rather than acquiring knowledge and instruction is a process of supporting that construction rather than communicating knowledge” [11]. “Individuals make sense of their own world and everything with which they come in contact by constructing their own representations or models of their experiences” [12]. Learning is not defined as simply the transmission of data from one individual to another, but as a social process whereby knowledge is co-constructed in a situation within a community of practice [13], [14]—as “situated action” [15] within socio-technical networks [16].

A. Socio-technical learning in the age of Web 2.0

According to [8], socio-technical systems consist of a “combination of organizational, technical, educational and cultural structures and interactions”. In summary, an online learning model with tele-operated labs must include the following dimensions:

1. An educational design (e.g., whole learning walk-through with guided discovery learning, learning modules)

2. a social design for online learning (e.g., communication, different social modes, contact to community)
3. a technical design (e.g., interfaces to the physical labs), and
4. an appropriate interplay of all three dimensions.

The proposed *socio-technical learning model* consists of a *learning walkthrough* with tele-operated experimentations (technical dimension; interfaces from online to the physical lab) connected to a distributed learning community (social dimension), and to learning modules with both teaching input and learning activities (educational dimension).

B. Exploratory, discovery, experiential, and experimental learning

In the presented set-up involving remote laboratories, exploratory learning is based on Internet-supported tele-operated, live experimentation in real-time in the field of mechanical engineering for different manufacturing technologies.

According to [18], “exploratory learning is an active process in which a learner (...) finds out and constructs his own meaning”. Learners “... interact with the world by exploring and manipulating objects, wrestling with questions and controversies, or performing experiments” [19]. This means learners explore something (e.g., hypotheses, ideas, and results) without a given narrow solution path. This type of learning model is demonstrated e.g., in case-based or project-based scenarios. An extended concept of this learning model is linking students’ learning with research [19]. This model of ‘inquiry learning’ is based on exploratory learning approaches also known as discovery learning [18].

Similar to discovery learning, Kolb’s “experiential learning theory” [20] covers four steps: *concrete experiences* (being involved in a situation, doing something), *active experimenting* (testing a theory by making a plan and following it), *reflective observing* (looking at an experience and thinking about it), and *abstract concept-making* (forming theories about why an experience happened the way it did).

In the PeTEX project, *experimental learning* is defined as combined forms of *discovery learning* and *experiential learning*. Experimental learning takes place within tele-operated laboratories using an online learning platform with an Internet-based access.

C. Experimental learning approach in online labs

An interactive experimental online-environment should facilitate the analysis of experimental results. This requires process accompanying theoretical and experimental learning tasks as well as the development of appropriate learning tools with a module-oriented layout.

In the PeTEX project, remote experimentations for forming, cutting, and welding tests will be designed. They will be tele-operated and monitored through video cameras and sensor elements providing the opportunity of varying input parameters as well as access to output results for analysis. The PeTEX remote experimentations platform offers experimental learning on the basis of continuous monitoring of visible material behavior and varying parameters, as well as on the basis of guidance through experiments for theoretical understanding.

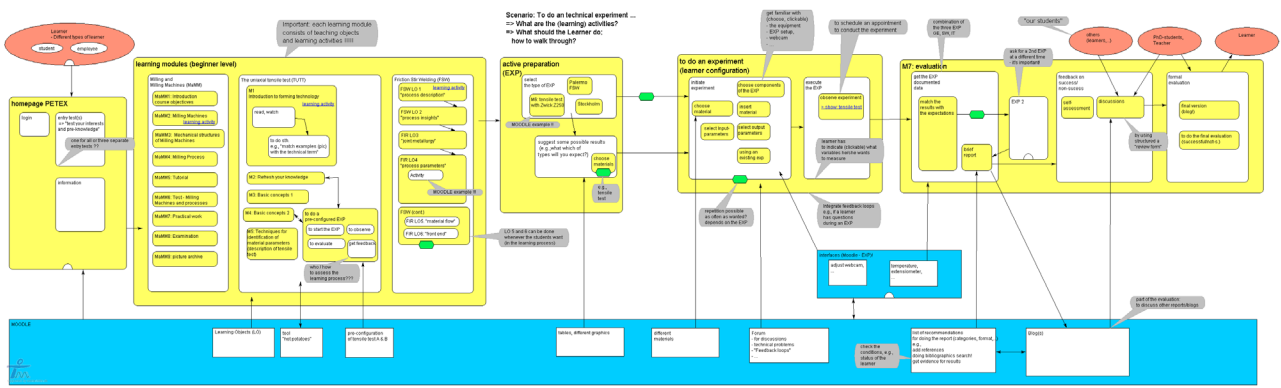

Figure 1. : Graphic model of experimental online learning (Screenshot PeTEX)

In the initial stage of the project, the laboratory equipment for the experiments is adapted to be suitable for tele-operated exploration. For continuous process monitoring, the equipment is supplemented with synchronized video-recording cameras located at different positions, continuously streaming the images of running experiments. Process data capture enables the monitoring of continuously changing parameters.

In a first step, the lab results obtained from these experiments in the form of both observation and measurement data will be evaluated by the learner. In a second step, the learners’ analytical process descriptions, interpretations, and theoretical assumptions will be peer-reviewed by other, more advanced learners.

In order to achieve this outcome, all of the technical as well as the social dimensions of these experimental learning and evaluation tasks must be embedded in the online learning environment.

III. CONCEPTUALIZATION OF THE E-LEARNING PLATFORM

A. Educational Modeling as Design-Based Research

From the perspective of an educational modeling and learning design, five elements play a central role in the development of the e-learning environment:

- design of knowledge-base, instructions methodology, and experiment environment (instructional and knowledge design),
- pedagogical conception and modeling of e-learning (educational design),
- design of coaching, learning-process, and learning-communication (communication design),
- multi- and hypermedia conception, formats, interfaces (media-oriented design),
- concepts of scalability, extendibility, maintainability and sustainability.

In recent years, the approach of Design-Based Research (DBR) has emerged [14]. Researchers, working together with educators and teachers, seek to refine theories of community building by designing, studying, and refining rich, theory-based improvements in realistic learning environments. DBR is a “systematic but flexible methodology aimed to improve educational practices through iterative analysis, design, development, and implementation, based on collaboration among researchers and practitioners in real-world settings, and leading to contextually-sensitive design principles and theories”

[22]. DBR consists of *several* phases of analysis (reflection) and design (interventions for improving learning models).

B. Design Based Research (DBR) and E-Learning Oriented Walkthrough (eLOW)

DBR in practice means to combine methods for data collection, analysis (e.g. formative evaluation) and development. A method for development is eLOW, described below.

From the domain of socio-technical systems [23] and participatory design [24], it is well known that one success factor for cultivating online groups is the engagement of future members as early as possible—in particular in the process of prototype building. According to the “Socio-Technical Walkthrough” (STWT) [19], the design of socio-technical arrangements in enterprises needs the integration of all stakeholders and target group members.

Adapted from [19], the *E-Learning-oriented Walkthrough* method (eLOW) supports such a design process in developing online learning environments. The main aspect of eLOW is to organize modeling workshops together with people from the target group (for whom the online platform will be developed); in PeTEX, engineering teachers and students are focused. Within these meetings, eLOW supports a group discussion that is connected with the development of a graphical model: teachers and students *walk-together-through* the learning processes, trying to anticipate how future learners will make use of the application. The walkthrough is guided by specific questions, for example, “what is attractive online learning with tele-operated labs? How does it look like?” Each answer during the discussion has to be visualized by deploying a software system for graphical modeling. The group discussions during the workshops are the basis for designing a model for online learning within a specific context and implementing a prototype guided by the model. (In PeTEX, the model focuses on experimental online learning in remote labs.) A first outcome was a graphical model that was team-designed with the graphical modeling software system “SeeMe” [25].

Fig. 1 shows the process model of the system specification-edited with SeeMe—for connecting learning objects to the telemetric experimental platform and the learner’s assessment activities. The oval element (red color) represents the “role” (e.g., learner, teacher), the rectangle with rounded corner (yellow color) represents the “activity” of the role, that is, what the role does (e.g. to do an experiment), and the rectangle (blue color)

represents an entity, technical system or resource. Moodle is the technical and graphical user interface of the entire system.

C. Competence Development as Learning Walkthrough

In this project, learning is conceptualized as a competence development activity. Competences can be achieved by distinguishing and pedagogically structuring the learning environment into knowledge-oriented, skill-oriented, and performance-oriented learning outcomes [21] so that they can provide the basis for learning activities.

The development of competences is designed as a “walk” through modularized learning objects (see Fig. 2), such as instructions (information, knowledge, methods, tools, etc.), learning activities (exploring the tele-operated experiments, data analysis, interpretation, summaries, structuring, questions, answers, etc.), and performance activities (collaboration, collection, producing glossaries, portfolio work, discussions, etc.).

Fig. 2 shows the socio-technical structure of the various modularized activities in the learning environment: a learner “walks” through these modularized learning activities, exploring research questions, conducting tele-operated experimentations, finding answers, making interpretations (discovery learning), and, finally, discussing results with peers and writing a report (final assessment).

- The red bar represents the learning community area, where the social software-components for course communication, user-generated content, and resource sharing have been integrated, e.g. a video-conferencing tool with screen-sharing functions, and the Moodle-tools for peer-reviewing (*Workshop*), forums, blogs, wikis, chat-channels, etc.
- The blue bar represents the *Backbone of Instruction*, integrating the interactive learning modules. These comprise the necessary theoretical foundations of the three experimental test beds.
- The yellow bar represents the three remotely accessed experimental test beds, and the related interactive software interfaces.

This framework facilitates the configuration of walkthroughs as specific training sequences for different levels, from beginner to advanced levels. The latter, more

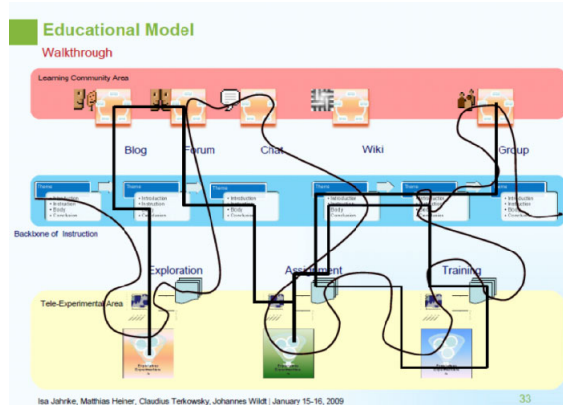

Figure 2. Educational Model – Walkthrough (the two different lines symbolize paths of two different learners)

complex self-directed exploratory- and problem-based learning walkthroughs will have comprehensive means of navigating through the entire environment, with the opportunity of interacting with all learning objects, and finding solutions for complex problems.

For the current prototype stage, PeTEX has defined three consecutive learning levels: 1) during the testing phase, the beginner-level students will receive a specified guideline for “walking” through the learning environment, and for carrying out a predefined experiment. 2) Intermediate-level learners will have wider opportunity for defining test bed settings, and, 3) advanced learners will have to solve a subject-specific real-world scenario, applying the learning objects, and experiments in a self-directed way.

D. Formative Evaluation

Formative evaluation is a type of evaluation, which has the purpose of continuously improving something [26], [27]. (In contrast, summative evaluation focuses on outcomes.) Formative evaluation can use any of the techniques, which are used in other types of empirical investigations: surveys, interviews, participant observation etc. In the analysis, this kind of formative evaluation was deployed for the revision of the learning model.

In PeTEX case, seven meetings for data collection, analysis, and development in different social modes were conducted. Hence, PeTEX has involved intended future learners and facilitators from university as well as from firms in the development of the prototype.

At these meetings, the target groups discussed experimental learning processes, simultaneously designed and co-constructed the model and evaluated it. Both the processes of designing and evaluating were guided via specific research and development qualitative questions (see above). The collection of qualitative data took place in group discussions which were recorded by audio and video. Notes were taken by an observer and later analyzed using open coding [28].

The qualitative feedback from the first-year evaluation meetings was very positive in general. The participants confirmed the “attractiveness” of the educational model. However, the evaluation experts also made a couple of useful recommendations for its improvement. See [29] and [30] for a detailed discussion of data collection, open coding for qualitative analysis, and dissemination of results, with regard to

- tele-operated experimentation design,
- social design,
- technical design, and
- educational design, especially learning modules.

In June 2010, formative evaluation workshops will take place at each of the three test bed-locations, deploying workplace studies with qualitative *thinking aloud method* (TAM), and quantitative questionnaires.

During the final prototyping phase, and after the system has gone into operation, qualitative and quantitative user-feedback will be collected constantly with Moodle’s on-board evaluation tools in order to progressively improve the PeTEX-system.

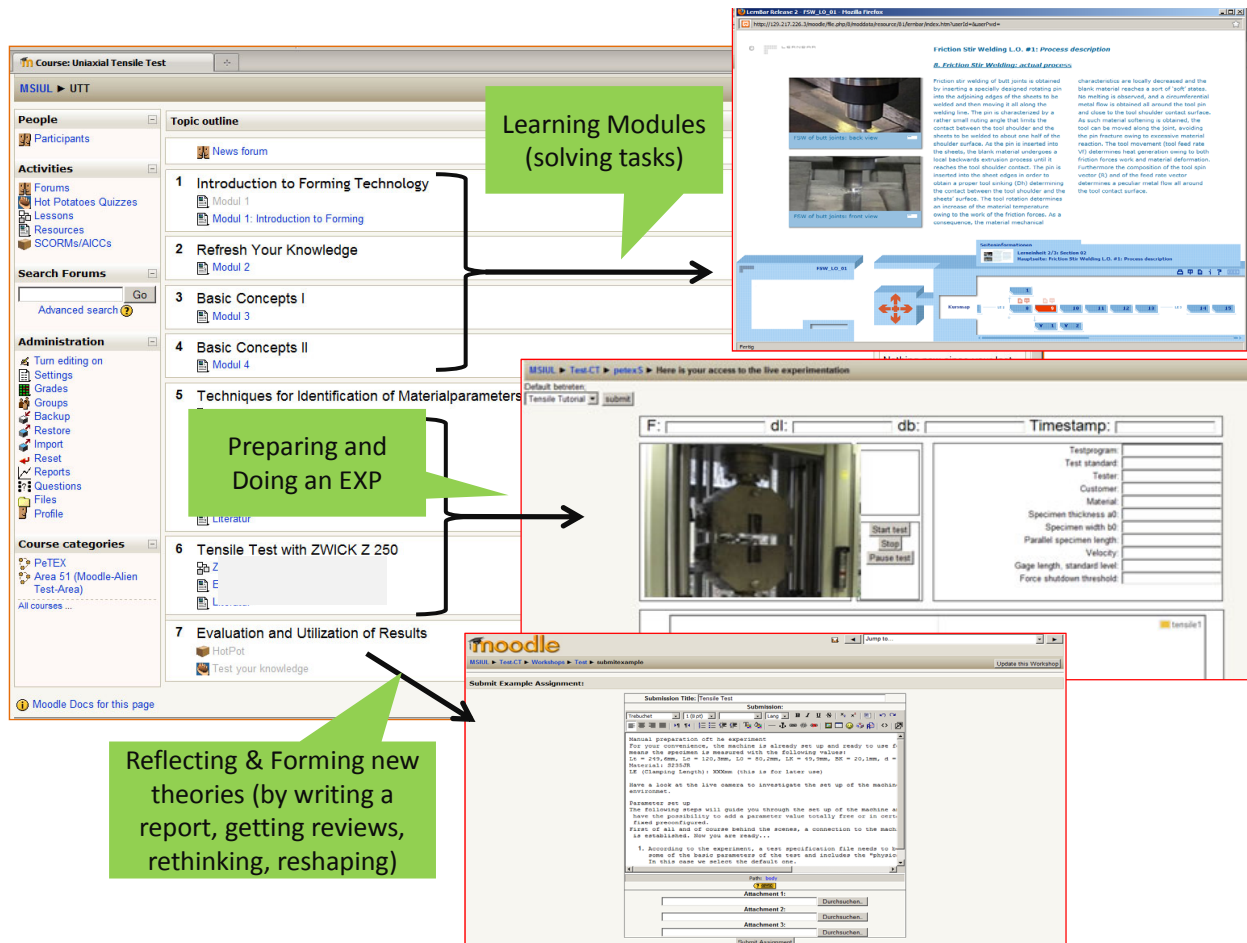

Figure 3. Experimental online learning (Screenshot PeTEX). In the background, the Moodle graphical user interface is to be seen. All PeTEX learning objects are integrated in or accessible via the Moodle-LMS.

E. Online environment Moodle

The PeTEX project-team decided to deploy Moodle (“Modular Object-Oriented Dynamic Learning Environment”, available at: <http://moodle.org/>) as the technical and graphical user interface as the basis for the PeTEX-system. Moodle is multilingual, and a widespread Open Source learning and content management tool. It is an online platform integrating learning objects in a highly modularized way. Hence, it facilitates e-learning design for individual as well as community activities in the form of path-oriented and self-directed walkthroughs. The characteristics of Moodle are compatible with the social constructivist approach, which holds that a new balance between teacher-led instructions and learner-led construction must be achieved.

Moodle allows course designers and facilitators to implement learning content and activities within a structure of so-called courses. A course consists of lessons, which can be organized in the topics format, in the weekly format or in the social format. A lesson consists of a sufficiently complex cluster of resources, activities, and blocks. Moodle provides a great variety of features and complex system-settings to organize different access levels (“roles”) and enrolment options. It facilitates social activities, e.g. course-communication and group-discussions, as well as tools for assignments, assessments, and evaluation, blogs and wikis, booking systems, and others. To date, the Moodle community has already developed more than 500 additional modules and plug-

ins, thus continuously enhancing and adapting the functionality of the application.

In addition to this wide variety, the PeTEX team has designed new and dedicated two major applications: a) service and web client for the interaction of data exchange including a user-interface for conduction tele-operated experiments, and b) a customized booking system for scheduling access time to the laboratory test-beds.

The data exchange service is at disposal in the add an activity drop down menu in the Moodle lesson editing modus. After activation, the link to experiment appears as regular component in the display of the lesson.

The service consists of an application for bidirectional data communication. The service exchanges data both with the routines of the test software, and with the developed Web-client that runs inside the user's browser. The web client, integrated into Moodle environment, enables the user to conduct the experiment, e.g. the uniaxial tensile test, with different parameter settings. The service and the Web-client, both consist of an appropriate user interface.

Depending on the learner-level, the parameter set-up-page is linked with the appropriate pages within the learning modules, or directly with the lesson-section of Moodle.

An additional module was integrated into Moodle, to allow the booking of the tele-operated test-beds. To this purpose, the already existing module MRBS (Meeting

Room Booking System) was considerably customized for integrating user administration as well as Moodle's own database.

All learning-objects are integrated in, or obtainable via Moodle. Fig. 3 shows the entire Moodle screen with the opened friction stir welding-course, consisting of seven lessons. The foreground shows: a) the interactive LernBar learning module, b) the Moodle-window for conducting the experiments, c) and the window with Moodle-tools for peer-reviewing (*Workshop*). It is also intended to install the *openmeeting* plug-in to allow for convenient video-conferencing, both within the entire learning-community as well as in the domain-specific courses.

F. E-Learning authoring with tool Lernbar.

The project team decided to additionally implement the e-learning authoring tool "LernBar" (<http://www.studium.digitale.uni-frankfurt.de/et/LernBar/index.html>) because it permits a very convenient content design and integration interface.

LernBar's development was financed by the *German Ministry for Education and Scientific Research* in the framework of the project *megadigitale* (2005-2007) at Goethe-University Frankfurt am Main. LernBar can be used without fees for academic purposes.

LernBar is a system for producing and publishing interactive learning content. It is an easy-to-use tool, which provides a wide variety of standardized and pre-designed templates for e-learning web-design. The authoring environment consists of several components, including a *studio* for producing and structuring courses and course content, as well as design templates, a storyboard-framework including design guidelines, a web-based portal for centralized publication of courses, as well as a browser-based *player* for interacting with the learning-modules in on-line and off-line mode.

LernBar offers several options of extending and embedding contents by a rich variety of interactive functions (e.g. quizzes, self-assessments, various question-formats designed with a text and graphic-based question editor, a drag-and-drop editor, a ranking editor, and further event-driven functions).

Course content in LernBar is based on XML, and can be enriched with common extensions available on the web (Adobe Flash, Java applet etc.) to enable a maximum of low level interoperability.

Because LernBar supports the IMS- and SCORM-standards, learning modules designed in the LernBar environment can be integrated into the Moodle environment without difficulty.

G. LernBar functionalities

Fig. 4 shows a LernBar-window on top of a Moodle-window. The LernBar-window is split into the presentation area at the top and the navigation area at the bottom. A page including two inserted video sequences with two different views of a friction stir welding process is depicted.

Fig. 5 shows another LernBar-window on top of a Moodle-window. Again, the LernBar-window is split into the presentation area at the top and the navigation area at the bottom. A page depicts a view of a single choice test.

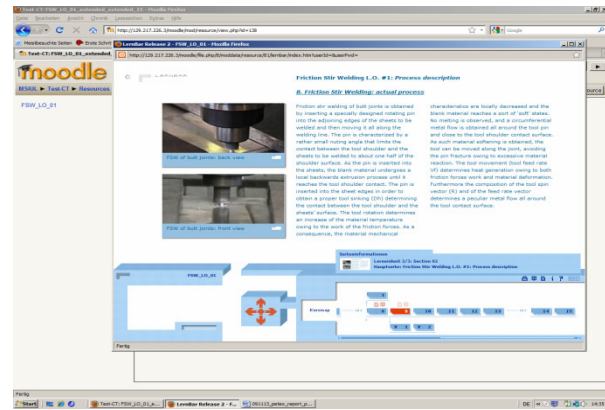

Figure 4. Two video-sequences of a fsw-process are integrated into the presentation area of LernBar

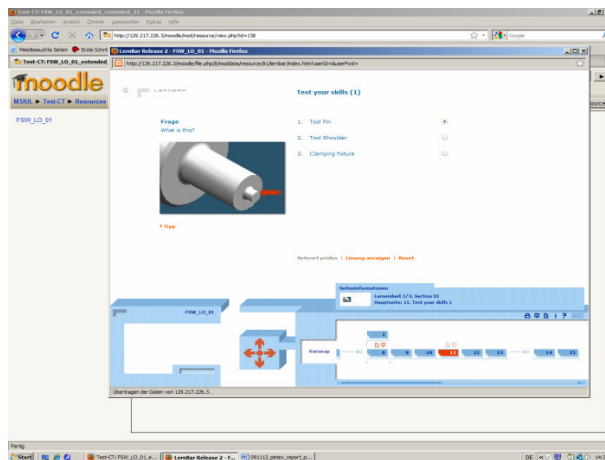

Figure 5. This screenshot shows a single-choice test-page designed with the LernBar editor

IV. IMPLEMENTATION OF THE TELE-OPERATED EXPERIMENT

The implementation of effective tele-operated experiments (here: tensile test, friction stir welding, and cutting operations) requires domain-specific know-how as well as the availability of certain equipment (machines, tools, and fixtures).

One of the most challenging steps of the implementation process was the development of the human-machine interface, that is, the control-facilities which have been integrated into the online-platform for the purpose of interaction between the user and the tele-operated experimental set-up.

A. Interfaces for data communication with experimental set-ups

Both the tele-operated experimental set-ups and the users' PCs are connected to the e-learning platform via the Internet. A detailed model of the technical interface for data communication between users' PCs, Moodle, and the tele-operated experimental set-up is shown in Fig. 6.

The tele-operated experiment is controlled by the control-PC (2). The control-PC also receives the data from the experiment (1) and processes them. Both the processed and the raw data are sent to the PeTEX Moodle-server (5) which distributes them to the clients (6, 7).

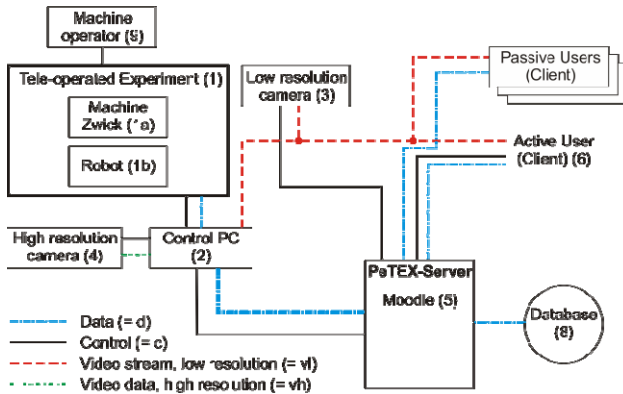

Figure 6. Model of the technical interface for data communication between users' PCs, Moodle, and the tele-operated experimental set-up

The low-resolution live video stream is sent to the active user conducting the tele-operated experiment (6) and potential passive users observing the experiment (7). The video streams do not cause any load on the PeTeX Moodle-server. The low-resolution live video stream is also sent to the control PC (2) which captures the data of the low-resolution video-camera (3) and stores them in a file.

The control PC (2) also captures the high-resolution camera data (4) and stores them in another file. Both videos plus the raw measurement data are sent to the PeTeX Moodle-server (5) and stored in a database (8). If required, the attending machine operator (9) prepares the tele-operated experiment.

The active user controls the experiments within Moodle. Common HTML-forms supported by every Web-browser (drop-down boxes, radio buttons, text input lines, etc.) capture the users' parameter inputs.

In order to visualize data in diagrams the developer-team chose the java script library FLOT (<http://code.google.com/p/flot>) (see Fig. 7). One advantage of FLOT is that it provides interactive commands like zooming and moving. Another advantage of FLOT is that it is licensed under the MIT license: (<http://www.opensource.org/licenses/mit-license.php>).

B. Experiment description: material characterization with the uniaxial tensile test

Generally, the uniaxial tensile test is understood as one of the most important experiments to investigate the material behavior under load. Material characterization, in particular mechanical testing with the uniaxial tensile test, is carried out to generate data on material forming procedures.

The most important function of mechanical testing is providing design data since detailed knowledge of limiting values is essential for deciding if a structure can withstand tension without failure. The uniaxial tensile test is deployed when calculating the yield stress of a material. It ensures that a test specimen of a material complies with its specifications and given requirements. Especially in forming, the elaborated characteristic parameters are used for setting up the forming process according to its technological parameters. The test can be carried out as a quantitative or a qualitative one.

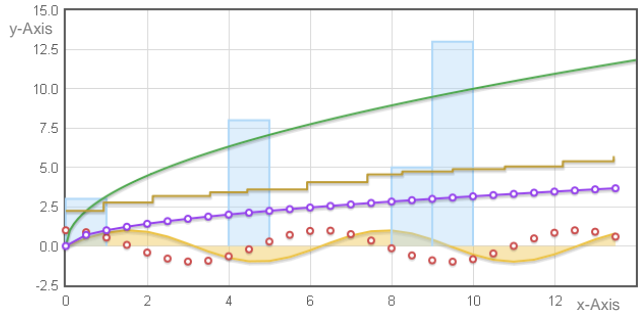

Figure 7. Example of supported graph types in FLOT java script library



Figure 8. Tensile test machine Zwick Z 250

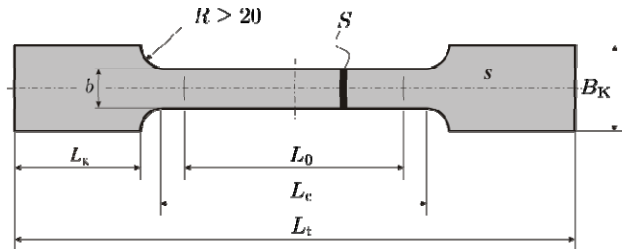

Figure 9. Tensile test specimen

1) Procedure

The tensile test within that project will be carried out by clamping the ends of a suitably prepared and standardized shaped specimen (DIN EN ISO 6892-1:2009-12), Fig. 7, in the universal test machine Zwick Z 250, Fig. 8, and then applying a continually increasing uniaxial load with a certain test-velocity until necking starts or failure occurs. During the initial project stage, the uniaxial tensile test set-up will be equipped manually.

2) Interaction

The uniaxial tensile test process (excluding, in the initial stage, the setting-up of the machine with the positioning and clamping of the specimen) will be controllable via an interface within Moodle. In order for the user to interact with the tele-operated tensile test, input options for adjusting parameters (e.g. movement speed) will be available. In Fig. 10, an overview is given of the available parameters for standard test programs, which can be entered in input fields or selected via index tab. The variable parameters of the chosen subset will be held within reasonable limits, 1) providing guidance for the learner with preconfigured test specifications, and 2) preventing damage of the machine.

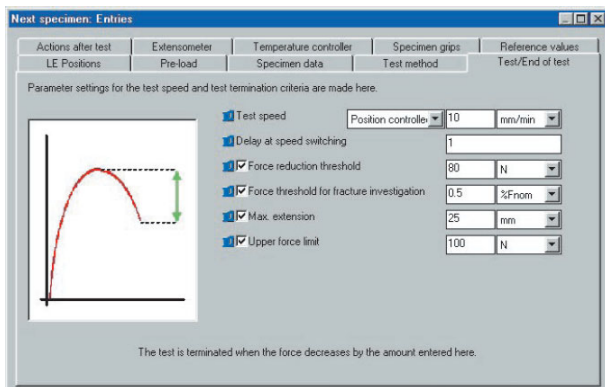

Figure 10. Set-up features

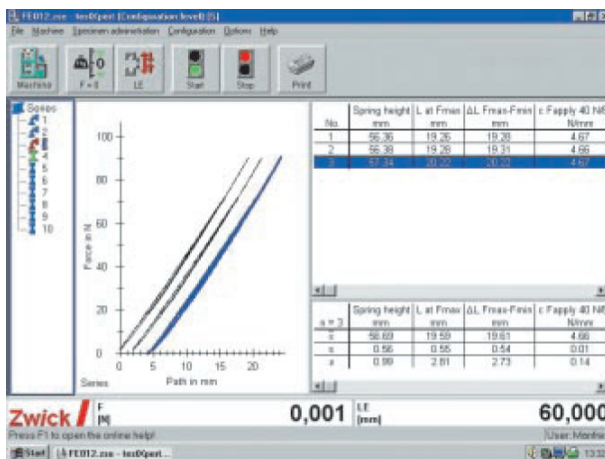

Figure 11. Analyzing features

Additionally, as shown in Fig. 11, the screen design of the testing software is suited to show all important operations, settings, and results in one window.

3) Monitoring

While the tensile test is carried out, the experiment will be monitored by different video cameras. The video images will enable the user to observe the effects of the tension on the specimen during and after the experiment with the option of focusing the camera lens on the relevant areas. The cameras will be positioned so as to allow for optimal observation.

The results of the experiment will be available 1) as graphical interpretation of load vs. displacement, 2) as tables containing pre-processed data, and 3) as raw ASCII code. The output can be compared both with available standard results and with results from experiments fed into in the PeTEX database. The database will be enlarged continuously with results from tele-operated experiments as well as from other in-house experiments for further investigation and comparison.

C. Experiment description: machining process

Milling is an extremely versatile manufacturing process, which allows the production of complex three-dimensional shapes (Fig. 12). Milling is a cutting process with geometrically defined edges and a workpiece that is fed into a rotating tool. Milling machines are usually deployed to machine flat surfaces, but can also machine irregular surfaces.

The workpieces are located on a pallet. The learner starts an automated process in which a robot picks up one



Figure 12. Milling machine



Figure 13. Robot and conveyor belt

workpiece from the pallet (Fig. 13), and places it on a conveyor belt. Then, another robot picks the workpiece from the conveyor belt, and places it on the magnetic fixture located on the machine tool table. Now, the milling operation starts, and the force data are recorded. The workpiece allows for a gradual increase of the radial depth of cut. Data from cutting forces are captured. Some important machining parameters like machining time, material removal rate, power, etc., are calculated for milling processes.

1) Climb vs. Conventional Milling

Conventional milling will be performed in forward direction, and climb milling will be performed in reverse direction (Fig. 14). In conventional milling, the workpiece is fed into the rotation of the cutter. This type of cut requires lower forces, and is preferred for roughing cuts. In climb milling, the workpiece moves with the rotation of the cutter. This produces a better finish. However, it is not recommended if the workpiece cannot be held safely, or cannot support high forces.

2) Experimental results

The learner is supposed to collect the measurement data from the force sensor, to process them, and to optimize the process. The analysis of cutting forces will be performed in order to evaluate:

1. tooth passing frequency
2. tool resonance frequency
3. effect of increasing/decreasing radial depth of cut
4. difference between conventional and climb milling

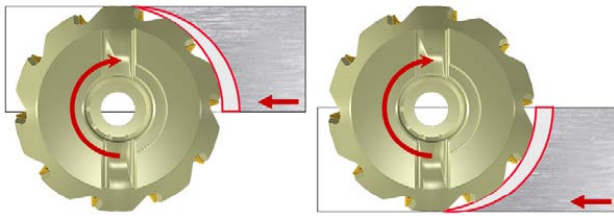

Upmilling

- Used on older machines / unstable conditions.
- Unfavourable milling process.

Downmilling (Climb milling)

- Favourable milling process.
- Not recommended on older machines / unstable conditions.

Figure 14. Two forms of the milling process

The learner monitors both the milling process and the data capturing by several cameras. In addition to the force calculation, the learner will check for limitation of machine power. If the machine power is not sufficient, the learner has to optimize the parameters accordingly.

D. Experiment description: friction stir welding (FSW)

The PeTEX welding experiments have been designed for two reasons: first, they must be interesting for the learners, showing different aspects of the process; second, the choice of geometrical and technological parameters must also be of interest for industry professionals. Therefore, the following choices were made:

- The three aluminum alloys most commonly used in industry were selected for the experiments, in order to demonstrate all relevant aspects of the process.
- One thickness value was identified, starting from the analysis of common applications in aeronautical, aerospace, naval and automotive industries.
- Two tools were designed in order to highlight the effect of the pin geometry (namely cylindrical and conical) on the joint final resistance, taking into account the differences in the material flow-induced by a given tool shape.
- A dedicated clamping fixture, allowing the process to be developed on an EMCO PCMILL300 CNC milling machine and, at the same time, the in-process force measurement was designed and developed.
- Preliminary communication tests were performed with the final aim to set up the tele-operated and video-recorded material tests on the specimen derived from the FS welded joints.

Learners will be able to configure and remotely carry out a FSW experiment using an EMCO PCMILL300 CNC milling machine (Fig. 15) equipped with a dedicated inhouse-designed clamping fixture; this fixture includes a dynamometer connected to a PC for in-process force measurements.

Additionally, the test specimen cut from the welded joints will be tested on a *Galdabini* universal testing machine equipped with a video camera for the online streaming of the tests. Since different devices have to be driven by remote users, there is the need of efficient interfaces allowing access via the Internet. The principle of this structure is shown in Fig. 16. The main devices are web cameras (low and high quality), a load cell, and a CNC milling machine.



Figure 15. The EMCO PCMill 300

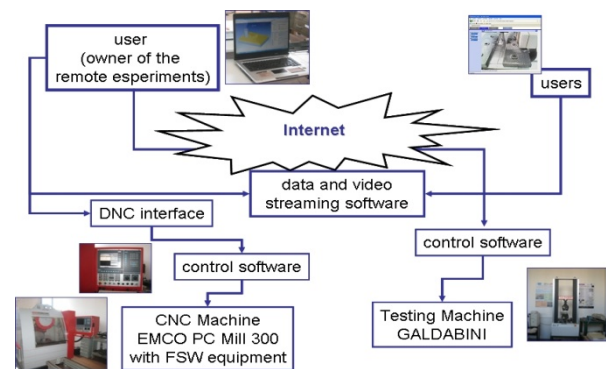

Figure 16. The FSW experiment structure

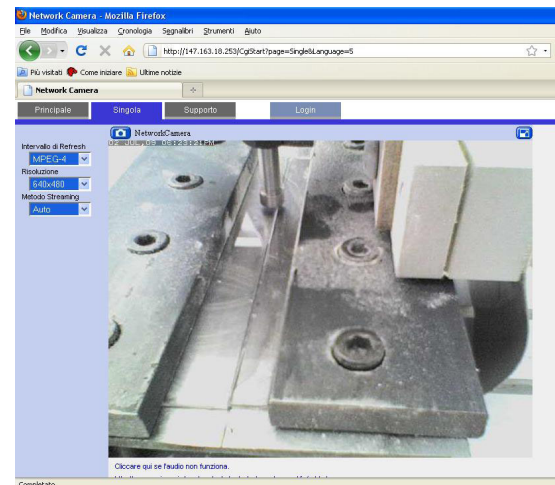

Figure 17. The webcam interface

Because of the need to both observe the experiments live and see detailed images of the working areas, two webcams will be used.

The low quality webcam (Fig. 17) provides users with a live video stream of the experiment. Low quality video clips can be easily broadcasted on the Internet with no interruptions, even if broadband connections are not available.

A load cell (Fig. 18) is connected to the device capturing the load data. Customized software is able to broadcast data on the Internet and show them on the remote learner's PC.

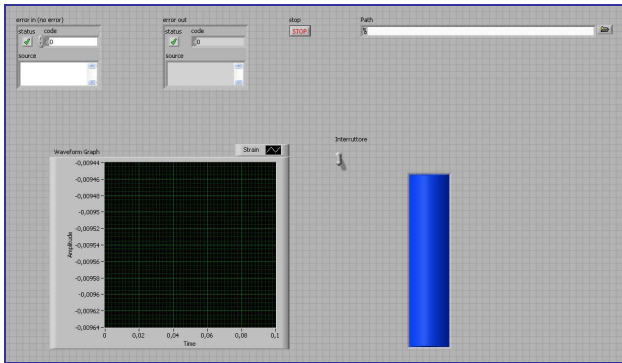

Figure 18. The load cell interface

Both the webcams and the load cell are driven by original software developed in the *LabVIEW* environment. The movie of the welding process, captured by a high quality webcam, will be stored in the database of the Moodle-server. Users will be able to download and save the movie files on their computers.

V. CONCLUSION

This paper has depicted important steps of interdisciplinary participatory design and development of a remote lab-prototype (based on the learning management system Moodle) in the field of manufacturing engineering. The possibility to run tele-operated experiments will enable users to get a full comprehension of those experiments, both from a theoretical point of view, and from a practical view of the potential for industrial application.

The introduced *Platform for e-Learning and Telemetric Experimentation* (PeTEX) aims at sharing valuable resources like machines and other infrastructure between dispersed locations. A collaborative learning environment is suggested to be crucial to the enhancement of learning results. Concerning this, all PeTEX learning objects and communication-tools are integrated in or accessible over the Moodle-LMS. The characteristics of Moodle are compatible with the social constructivist approach, which holds that a new balance between teacher-led instructions and learner-led construction must be achieved. For this purpose, an educational framework is designed integrating the Moodle-based tele-operated experimentation platform with teaching content and learning activities in order to support a successful learning walkthrough. Furthermore, the deployed walkthrough concept can be adapted to a wide range of professional as well as educational frameworks.

Thanks to new IT technologies, both teachers and experts can create, publish, and disseminate advanced educational objects—and educational objectives. Moreover, by ICT technologies teachers can obtain an individual impact on learners regardless of space and time bounds, at the same time capturing the attention of the younger because of their interest in new viewpoints.

On the basis of its modularity, the PeTEX-prototype will be extendable with new experiments in the future. New test beds can be connected to the LMS, allowing further experiments to be conducted, although, the major technical challenge remains the equipping of laboratory test beds for tele-operation, which actually are not designed for remote access [5].

Another prospective goal is to increase the levels of both automation and interaction of the tele-operated experiments presented in this paper.

ACKNOWLEDGMENT

PeTEX sincerely thanks **S. Voss, D. Weiß, A. Mereu, C. Bremer, R. Müller, Dr. A. Tillmann and Prof. Dr. D. Krömker** from *studiumdigitale - Zentrale eLearning-Einrichtung der Goethe-Universität Frankfurt/Germany* for providing and supporting us with *LernBar*, **N. Karcan** from TU Dortmund University (HDZ) for elaborate web-authoring with *LernBar* and *Moodle*, **Prof F. Micari**, University of Palermo, Italy (DTMPIG), **Dr.-Ing. habil. S. Chatti, M. Spiess, M. Sappok, S. Grunert**, TU Dortmund University (IUL), **M. Schaefer**, TU Dortmund University (HDZ), **Dr. P. Ilyes**, Goethe-University Frankfurt/Germany (*Science and Technology Studies*, Institute for Cultural Anthropology and European Ethnology), and **Dr.-Ing. U. Dirksen**, Poynting GmbH, Dortmund, Germany for strong support.

REFERENCES

- [1] Harward, V. Judson, Jesus A. del Alamo, Steven R. Lerman, et al., "The iLab Shared Architecture: A Web Services Infrastructure to Build Communities of Internet Accessible Laboratories," Proc. IEEE Volume: 96 Issue: 6 pp. 931 – 950, 2008.
- [2] M. E. Auer and A. Pester, "Online Engineering as a New Challenge in Higher Education": University & Industry - Knowledge Transfer and Innovation, WSEAS Press Athens New York, 2009
- [3] D. Lowe, S. Murray, D. Li and E. Lindsay, "Remotely Accessible Laboratories – Enhancing Learning Outcomes. Project Report" Australian Learning and Teaching Council 2008
- [4] Ingvar Gustavsson, Kristian Nilsson, Johan Zackrisson, Javier Garcia-Zubia, Unai Hernandez-Jayo, Andrew Nafalski, Zorica Nedic, Özdemir Göl, Jan Machotka, Mats I. Pettersson, Thomas Lagö, Lars Håkansson, "On Objectives of Instructional Laboratories, Individual Assessment, and Use of Collaborative Remote Laboratories," IEEE Transactions on Learning Technologies, vol. 2, no. 4, pp. 263-274, Oct.-Dec. 2009, doi:10.1109/TLT.2009.42
- [5] L. Gomes and S. Bogosyan, "Current Trends in Remote Laboratories," IEEE Transactions on Industrial Electronics, vol. 56, no. 12, pp. 4744-4756, Dec. 2009. doi:10.1109/TIE.2009.2033293
- [6] C. Pleul, I. Jahnke, C. Terkowsky, U. Dirksen, M. Heiner, J. Wildt, A. E., „Experimental E-Learning – Insights from the European Project PeTEX” Book of Abstracts – Online-Educa-Berlin 2009” Berlin, ICWE GmbH, pp 47-50.
- [7] E. Bolisani, E., Building the Knowledge Society on the Internet. Hershey (PA): Information Science Reference, IGI Global, 2008.
- [8] F. Kensing and J. Blomberg, "Participatory Design: Issues and Concerns" In Computer Supported Cooperative Work, vol. 7, pp. 167–185, 1998. doi:10.1023/A:1008689307411
- [9] Th. Herrmann, "Learning and Teaching in Socio-technical Environments," in Proceedings of the IFIP TC3/WG3.1&3.2 Open Conference on Informatics and The Digital Society: Social, Ethical and Cognitive Issues on Informatics and ICT, p.59-71, July 22-26, 2002, published 2003
- [10] R.B. Barr and J. Tagg, "From Teaching to Learning - A New Paradigm for Undergraduate Education", Retrieved from <http://ilte.ius.edu/pdf/BarrTagg.pdf>, 1995.
- [11] A. Collins and R. Halverson R., Rethinking Education in the Age of Technology: The Digital Revolution and Schooling in America. Teachers College Press. 2009.
- [12] D.H. Jonassen, K.L. Peck and B.G. Wilson. "Learning With Technology. A Constructivism Perspective. Upper Saddle River, 1999.
- [13] J. Lave and E. Wenger, *Situated learning: Legitimate peripheral participation*. New York: Cambridge University Press, 1991.
- [14] T. Reeves, J. Herrington and R. Oliver, "Design research: A socially responsible approach to instructional technology research

- in higher education”, in *Journal of Computing in Higher Education*, vol. 16, pp. 97-116, 2005.
- [15] L. Suchman, *Human-Machine Reconfigurations: Plans and Situated Actions* (2nd Edition). Cambridge: Cambridge Press, 2007.
- [16] B. Latour, *Reassembling the Social: An Introduction to Actor-Network-Theory*. Oxford: Oxford University Press, 2005.
- [17] M. Boettger and M. Roell, “Weblog publishing as support for exploratory learning on the World Wide Web”, in *Proceedings Cognition and Exploratory Learning in Digital Age* (CELDA 2004), Lisbon, Portugal, Nov. 2004.
- [18] Bruner, J. S. (1967). *On knowing: Essays for the left hand*. Cambridge, Mass: Harvard University Press. Retrieved February 8th, 2010 from <http://www.learning-theories.com/discovery-learning-bruner.html>
- [19] A. Jenkins, R., Breen and R. Lindsay, *Reshaping teaching in higher education. Linking teaching with research*. New York: Routledge, 2007.
- [20] D. Kolb and R. Boyatzis, R., “Experiential Learning Theory: Previous Research and New Directions”, in R. J. Sternberg and L. F. Zhang (Eds.), *Perspectives on cognitive, learning, and thinking styles*. NJ: Lawrence Erlbaum, 2000.
- [21] L. D. Feisel and A. J. Rosa, “The Role of the Laboratory in Undergraduate Engineering Education”, *Journal of Engineering Education*, 94(1): 2005, pp. 121-130.
- [22] F. Wang and M.J. Hannafin, M. J., “Design-based research and technology-enhanced learning environments”, in *Educational Technology Research & Development*, 53 (4), pp. 5-23, 2005, p. 6
- [23] B. Whitworth and A. de Moor, A. (Eds.). *Handbook of Research on Socio-Technical Design and Social Networking Systems*. IGI Global Publisher, 2009.
- [24] F. Kensing and J. Blomberg, “Participatory Design: Issues and Concerns” In *Computer Supported Cooperative Work*, vol. 7, pp. 167-185, 1998. doi:10.1023/A:1008689307411
- [25] Th. Herrmann, *SeeMe in a Nutshell*. http://www.imtm-iaw.rub.de/imperia/md/content/seeme/seeme_in_a_nutshell.pdf, 2006. Retrieved March 8th, 2008.
- [26] I. Jahnke and M. Koch, “Web 2.0 goes academia: Does Web 2.0 make a difference?” In *International Journal Web Based Communities*, Vol. 5, No. 4, 2009, pp. 484-500, 2009.
- [27] C. Weston, C. Le Maistr, L. Mcalpine and T. Bordonaro, T., “The influence of participants in formative evaluation on the improvement of learning from written instructional materials”, In *Instructional Science*, vol. 25, pp. 369-386, 1997. doi:10.1023/A:1003073923764
- [28] I. Jahnke, “Dynamics of social roles in a knowledge management community”, in: *Computers in Human Behavior*. Oxford (UK): Elsevier. 25, 2009.
- [29] I. Jahnke, C. Terkowsky C. Pleul, and A.E. Tekkaya, “Lab Didactics: Experimental Online Learning within Remote Laboratories”, unpublished.
- [30] I. Jahnke, C. Terkowsky, C. Pleul, and A.E. Tekkaya, “Online Learning with Remote-Configured Experiments”, Conference Proceedings Mensch und Computer / Delphi 2010, in print.

AUTHORS

C. Terkowsky, Dipl.-Paed., is with the TU Dortmund University, Center for Research on Higher Education and Faculty Development, Vogelpothsweg 78, D-44227 Dortmund (e-mail: claudius.terkowsky@tu-dortmund.de).

I. Jahnke, Assistant Professor, Dr. phil., is with the TU Dortmund University at the Center for Research on

Higher Education (HDZ), Vogelpothsweg 78, D-44227 Dortmund (e-mail: isa.jahnke@tu-dortmund.de).

C. Pleul, né: Burkhardt, M.Sc. M.Eng, is with the TU Dortmund University, Institute of Forming Technology and Lightweight Construction, Baroper Str. 301, D-44227 Dortmund (e-mail: christian.pleul@udo.edu).

R. Licari, PhD, is with the University of Palermo, Department of Mechanical Technology, Production and Management Engineering (DTMPIG), viale delle Scienze, I-90128 Palermo (rlicari@dtpm.unipa.it).

P. Johannssen, Ass. Prof., is with the KTH, Industrial Engineering and Management Department of Production Engineering, Brinellvägen 68 S-100 44 Stockholm, (per.johansson@iip.kth.se)

G. Buffa, PhD, is with the University of Palermo, Department of Mechanical Technology, Production and Management Engineering (DTMPIG), viale delle Scienze, I-90128 Palermo (g.buffa@dtpm.unipa.it).

M. Heiner, university lecturer and researcher, is with the TU Dortmund University, Center for Research on Higher Education and Faculty Development, Vogelpothsweg 78, D-44227 Dortmund (e-mail: matthias.heiner@tu-dortmund.de).

L. Fratini, Prof., is with the University of Palermo, Department of Mechanical Technology, Production and Management Engineering (DTMPIG), viale delle Scienze, I-90128 Palermo (fratini@dtpm.unipa.it).

E. Lo Valvo, Prof., is with the University of Palermo, Department of Mechanical Technology, Production and Management Engineering (DTMPIG), viale delle Scienze, I-90128 Palermo (elovalvo@dtpm.unipa.it).

M. Nicolescu, Prof., is with the KTH, Industrial Engineering and Management Department of Production Engineering, Brinellvägen 68 S-100 44 Stockholm (mi-hai@iip.kth.se).

J. Wildt, Prof. Dr. Dr. hc, is with the TU Dortmund University at the Center for Research on Higher Education (HDZ), Vogelpothsweg 78, D-44227 Dortmund (johannes.wildt@tu-dortmund.de).

A. E. Tekkaya, Prof. Dr.-Ing., is with the TU Dortmund University, Institute of Forming Technology and Lightweight Construction, Baroper Str. 301, D-44227 Dortmund, Germany (e-mail: Erman.Tekkaya@tu-dortmund.de)

This project has been funded with support from the European Commission.

This article was modified from a presentation at the REV2010 Conference at KTH, Stockholm, Sweden in June 2010. Submitted July 15th, 2010. Published as resubmitted by the authors July 29th, 2010.

This publication reflects the views only of the author, and the Commission cannot be held responsible for any use which may be made of the information contained therein.

